



CD40022 WITH CIMO320

## Features

- Only 22" (559 mm) wide.
- Storage 120 lbs (54 kg) of ice per day.
- *Turbo Dispense* dispenses 1/4 lbs of ice per second.
- *Power Clean* allows access to the bin for easy cleaning without moving the ice machine. Interlock safety switch turns off machine agitation when top-front access panel is removed.
- 4" (102 mm) foam insulation for maximum ice preservation – no more quick melting ice.
- Constructed from corrosion-resistant stainless steel and fingerprint-proof plastic.
- Great for hard water, food safety and tight spaces.
- User friendly push-to-dispense operation.

CD40022/40522 CUBE ICE DISPENSER

## Ice Form

### CUBE



Full Cube Dimensions	
W x D x H (in.)	7 <sup>5</sup> / <sub>8</sub> x 7 <sup>5</sup> / <sub>8</sub> x 7 <sup>5</sup> / <sub>8</sub>
W x D x H (mm)	22 x 22 x 22
Half Cube Dimensions	
W x D x H (in.)	3 <sup>5</sup> / <sub>8</sub> x 7 <sup>5</sup> / <sub>8</sub> x 7 <sup>5</sup> / <sub>8</sub>
W x D x H (mm)	10 x 22 x 22

ICE PRODUCTION FOR OPTIONAL CUBE ICE MAKERS—LBS. (KG) PER 24 HOURS*								
Model Number	ICEO320	ICEO325	ICEO520	ICEO525	ICEO826	ICEO825	ICET126	ICET125
Air	313 (142)	290 (132)	561 (254)	529 (240)	896 (406)	922 (418)	932 (423)	937 (425)
Water	316 (143)	N/A	586 (266)	N/A	N/A	N/A	N/A	N/A
Remote	N/A	N/A	N/A	N/A	906 (411)	912 (414)	968 (439)	1035 (469)
Voltage	115/60/1	220-240/50/1	115/60/1	220-240/50/1	208-230/60/1	220-240/50/1	208-230/60/1	220-240/50/1

\*Tested at 70°F Air/50°F Water.

All specifications and performance data are subject to normal manufacturing variances.  
Daily ice production based on half cube configuration.

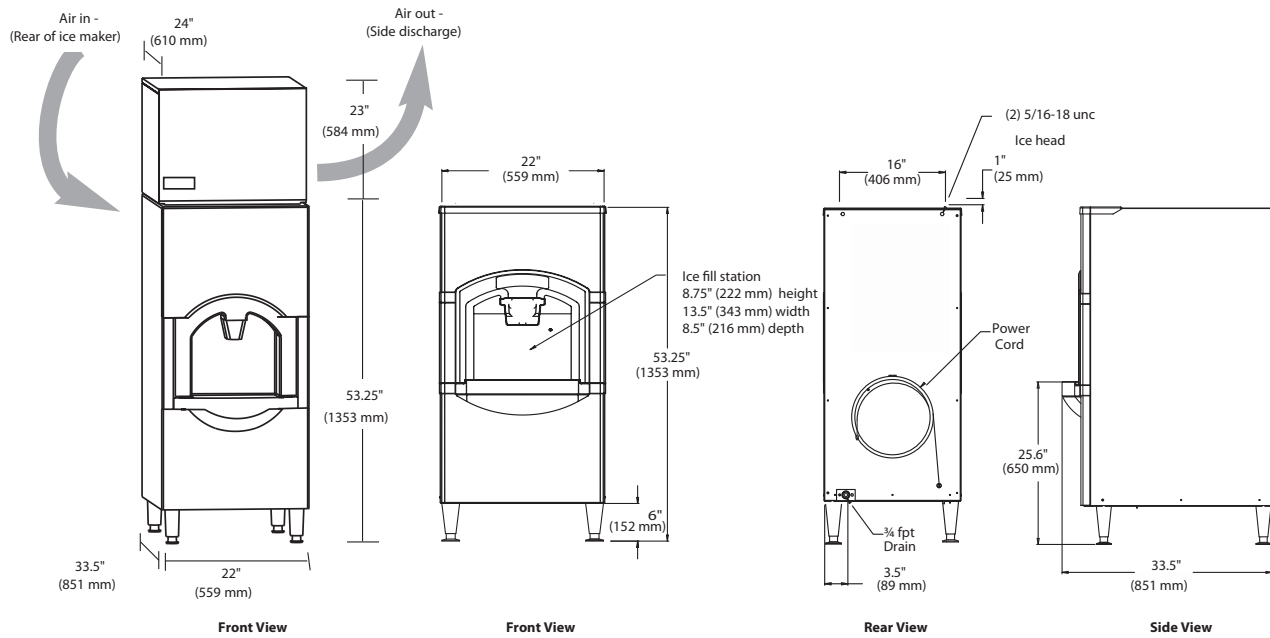

### Operating Requirements

	MINIMUM	MAXIMUM	
		60 Hz	50Hz
Ambient Temp. Range Air	50°F (10°C)	100°F (38°C)	110°F (43°C)
Water Temp.	40°F (4.4°C)		90°F (32°C)
Water Pressure	20 PSIG (1.4 BAR)	60 PSIG (4.1 BAR)	

### Dimensions (dispenser only)

ALL MODELS	
W x D x H (in.)	22 x 33.5 x 53.25
W x D x H (mm)	559 x 851 x 1,353

### Specifications

Model Number	Dispenser Operation	ARI Bin Storage lbs (kg)	Voltage Characteristics	Min. Circuit Ampacity	Max Fuse Size
CD40022*	Push	120 (55)	115/60/1	2.1	15
CD40522	Push	120 (55)	230/50/1	2.1	15

Note #1: Model CD40022 and CD40522 dispensers accept all 22" CIM Series™ Cube Ice Makers.  
Note #2: CD40022 and CD40522 Series units do not require an Adaptor and Bin Level Kit.

NOTES:  
Number of Wires: 3 (including ground)  
Approx. Shipping Weight lbs (kg): 230 (105)  
Refrigerant Type: R404A  
\*Cordset included